



QUALITY SPECIFICATIONS

Table of Contents

- SCOPE and FIGURE 1 Viewing Conditions 1
- FLAT GLASS 2
- EDGEWORK & FABRICATION 4
- MIRROR 6
- TEMPERED GLASS 9
- LAMINATED GLASS..... 13
- INSULATED GLASS 15
- METAL FABRICATION..... 19
- TERMINOLOGY 23
- VISUAL AIDS..... 25

QUALITY

SPECIFICATIONS

Scope:

This document defines the quality standards, tolerances, and appearance criteria for glass and metal products manufactured and fabricated by Heartland Glass. Refer to the appropriate section for the product being inspected.

- Outsourced product specifications may vary from the HG specifications detailed in this document. Speak with your sales representative regarding outsourced product specifications prior to ordering.
- As you use the FIG. 1 inspection criteria below, refer to the specified viewing distance for the product being inspected.
- Inspection lighting should be daylight or uniform diffused overhead lighting. No direct sunlight or other direct lighting should be used in transmission (through the glass) or reflection to inspect for blemishes.
- These viewing conditions and inspection lighting best simulate how glass will most commonly be looked through while in service. These viewing conditions are based on ASTM C1036 specifications, and are the standard industry-wide.

FIGURE 1 - VIEWING CONDITIONS FOR BLEMISH DETECTION:

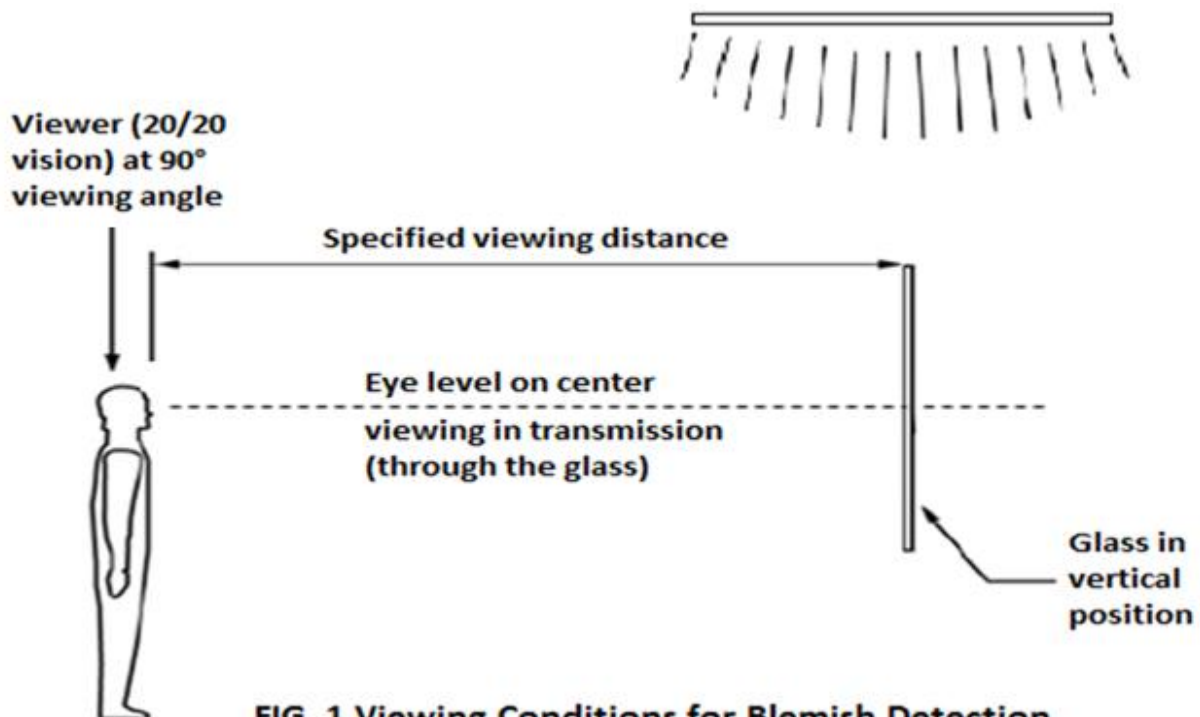

FIG. 1 Viewing Conditions for Blemish Detection

Quality Specifications for: **FLAT GLASS**

This section covers the criteria and tolerances specific to clear or tinted, annealed monolithic flat glass. These specifications are based on ASTM C1036 Standard Specification for Flat Glass, Quality 3 (Q3) or better.

Linear Blemish <i>(scratch, rub, dig or similar imperfections – see p. 21 for examples)</i>		
BLEMISH INTENSITY	DETECTION DISTANCE	LINEAR BLEMISH TOLERANCE <i>(clean cut or seamed edge)</i>
Heavy	Over 11'	None allowed
Medium	11' to 36"	None allowed
Light	36" to 8"	Allowed
Faint	Under 8"	Allowed

STOCK SHEET tolerance = No heavy blemishes allowed. Medium blemishes less than 3" long are allowed.

- To determine blemish intensity, stand at approximately **12'** under viewing conditions in FIG. 1. Move closer until blemish becomes readily apparent. This is the detection distance.

Point Blemish <i>(seed, dirt or similar imperfections – see p. 21 for examples)</i>	
POINT BLEMISH SIZE	POINT BLEMISH TOLERANCE <i>(clean cut or seamed edge)</i>
< 1/32"	Allowed
1/32" – 1/16"	Allowed with a minimum separation of 24"
>1/16"	None allowed

STOCK SHEET tolerance = Point blemishes 1/16" and under are allowed without restriction. 2 point blemishes > 1/16" allowed per stock sheet.

- Inspect for point blemishes at **36"** per viewing conditions in FIG. 1. All point blemishes not readily apparent at this distance are allowed.
- Point blemish size = (width + length) / 2
- Point blemish size for this inspection does not include any associated distortion.

Chip Tolerance <i>(on clean cut or seamed edges) (see p. 21 for chip visual aids)</i>			
GLASS THICKNESS	CHIP DEPTH max (50% of glass thickness)	CHIP WIDTH max	CHIP LENGTH max
3/32"	3/64"	1/8"	1/4"
1/8"	1/16"	1/8"	1/4"
5/32"	5/64"	5/32"	1/2"
3/16"	3/32"	3/16"	
1/4"	1/8"	1/4"	
3/8"	3/16"	1/4"	
1/2"	1/4"	1/4"	
3/4"	3/8"	1/4"	
Stock Sheet	≤ 50% of glass thickness	Not Limited	Not Limited

- No V-chips are allowed
- Corner chips fall under size tolerance allowances
- Edge seaming maximum: follow chip width specifications

Dimensional Size Tolerance		
GLASS THICKNESS	WIDTH and LENGTH	
	CLEAN CUT or SEAMED EDGE	STOCK SHEET
3/32" - 1/4"	1/16"	1/2"
3/8"	3/32"	1/2"
1/2"	1/8"	1/2"
3/4"	3/16"	1/2"
CUSTOM SHAPE 99s (customer provided pattern): Add ± 1/16" to all size tolerances		

Squareness Tolerance		
GLASS THICKNESS	<i>(measured diagonally corner to corner)</i>	
	CLEAN CUT or SEAMED EDGE	STOCK SHEET
3/32" - 1/4"	5/64"	N/A
3/8"	1/8"	N/A
1/2"	11/64"	N/A
3/4"	1/4"	N/A

Quality Specifications for:

EDGEWORK & FABRICATION

This section covers the criteria and tolerances specific to glass with edgework and other fabrication processes, such as holes, notches and cut-outs. These specifications are based on ASTM C1036 Standard Specification for Flat Glass, Quality 2 (Q2) or better, and ASTM C1048 Section 7, Fabrication for Tempered Glass.

Linear Blemish (<i>scratch, rub, dig or similar imperfections – see p. 21 for examples</i>)		
BLEMISH INTENSITY	DETECTION DISTANCE	LINEAR BLEMISH TOLERANCE (<i>glass with edgework or other fabrication</i>)
Heavy	Over 11'	None allowed
Medium	11' to 36"	None allowed
Light	36" to 8"	Allowed if ≤ 3 " length with a minimum separation of 48"
Faint	Under 8"	Allowed

- To determine blemish intensity, stand at approximately **12'** under viewing conditions in FIG. 1. Move closer until blemish becomes readily apparent. This is the detection distance.

Point Blemish (<i>seed, dirt or similar imperfections – see p. 21 for examples</i>)	
POINT BLEMISH SIZE	POINT BLEMISH TOLERANCE (<i>glass with edgework or fabrication</i>)
$< 1/64$ "	Allowed without restriction
$1/64$ " – $1/32$ "	Allowed with a minimum separation of 24"
$>1/32$ " – $1/16$ "	Allowed with a minimum separation of 60"
$>1/16$ "	None allowed

- Inspect for point blemishes at **36"** per viewing conditions in FIG. 1. All point blemishes not readily apparent at this distance are allowed.
- Point blemish size = (width + length) / 2
- Point blemish size for this inspection includes any associated distortion.

Dimensional Size Tolerance (<i>glass with edgework or other fabrication</i>)		
GLASS THICKNESS	WIDTH and LENGTH	SQUARENESS (<i>measured diagonally corner to corner</i>)
$3/32$ " – $1/4$ "	$1/16$ "	$5/64$ "
$3/8$ "	$1/16$ "	$5/64$ "
$1/2$ "	$3/32$ "	$1/8$ "
$3/4$ "	$1/8$ "	$11/64$ "
CUSTOM SHAPE 99s (customer provided pattern): Add $\pm 1/16$ " to all size tolerances		

POLISHED and GROUND Edgework:

- Edge chips: not allowed if visible from **36"** when viewed per FIG. 1
- Corner chips: not allowed if visible from **60"** when viewed per FIG. 1
- Polish or grind marks: not allowed if visible from **60"** when viewed per FIG. 1
- Shiners/skips: not allowed

HOLES:

- Hole diameter: $\pm 1/16"$
- Hole center from specified edge: $\pm 1/16"$
- Between hole centers: $\pm 1/16"$
- Chips / flakes at unpolished hole edges: $1/16"$ maximum width

NOTCHES & CUTOUTS:

- Glass edge to notch edge: $\pm 1/16"$
- Notch edge to notch edge: $\pm 1/16"$
- Notch center from specified edge: $\pm 1/16"$
- Chips / flakes at unpolished edges: $1/16"$ maximum width
- Notch / cutout size tolerance for glass thickness $1/2"$ or less: $\pm 1/16"$
- Notch / cutout size tolerance for glass thickness greater than $1/2"$: $\pm 1/8"$

BEVELS:

- Bevel width: $\pm 1/16"$
- Bevel parallel with glass edge: $\pm 1/32"$
- Corner match: $\pm 1/8"$ on 90 degree angle, $\pm 1/4"$ on non 90° angle
- Edge thickness: $\pm 1/32"$

WATERJET Edgework:

- No quality criteria. Not intended as an exposed edge. See: HOLES, NOTCHES & CUTOUTS for location and chip tolerances.

SEAMED Edgework:

- No quality criteria. Not intended as an exposed edge. See: FLAT GLASS (p.2) for tolerances.

LAMINATED Glass Edgework:

- Interlayer edge defect tolerance: $1/32"$

Interlayer edge defects include edge boil, blow-in, short interlayer, unlaminated areas, etc. For interlayer blemishes not along the edge, or for clean cut/seamed laminated glass, see LAMINATED GLASS section.

Quality Specifications for:

MIRROR

This section covers the criteria and tolerances specific to silvered flat glass mirrors supplied as cut sizes or stock sheets. For mirror edgework and fabrication tolerances, see EDGEWORK & FABRICATION section. These specifications are based on ASTM C1503 Mirror Glazing Quality or better.

NOTE: For mirror inspection per FIGURE 1, a viewing angle of ± 10 degrees is allowable.

Linear Blemish <i>(scratch, rub, dig or similar imperfections – see p. 21 for examples)</i>		
BLEMISH INTENSITY	DETECTION DISTANCE	LINEAR BLEMISH TOLERANCE <i>(clean cut or seamed edge)</i>
Heavy	Over 5'	None allowed
Medium	5' to 24"	None allowed
Light	24" to 8"	Allowed if ≤ 3 " length with a minimum separation of 24"
Faint	Under 8"	Allowed

- To determine blemish intensity, stand at approximately **6'** under viewing conditions in FIG. 1, **± 10 degrees**. Move closer until blemish becomes readily apparent. This is the detection distance.

Linear Blemish – STOCK SHEET			
BLEMISH INTENSITY	DETECTION DISTANCE	CENTRAL	OUTER
Heavy	Over 5'	None allowed	Allowed if ≤ 3 " length with a minimum separation of 48"
Medium	5' to 24"	None allowed	Allowed if ≤ 3 " length with a minimum separation of 48"
Light	24" to 8"	Allowed if ≤ 3 " length with a minimum separation of 24"	Allowed with a minimum separation of 24"
Faint	Under 8"	Allowed	Allowed

Silver Film Blemish
Allowed if not readily apparent from 36" per viewing conditions in FIG. 1, ± 10 degrees

Point Blemishes for Mirror <i>(seed, dirt or similar imperfections – see p. 21 for examples)</i>			
SIZE	CENTRAL	OUTER	STOCK SHEET
< .30mm	Allowed (no clusters)	Allowed (no clusters)	Allowed (no clusters)
(.012")			
(1/84")			
≥ .30mm - <.50mm	Allowed with a minimum separation of 12"	Allowed with a minimum separation of 12"	Allowed (no clusters)
(≥.012" - <.02")			
(≥1/84" - <1/50")			
≥ .50mm - <.80mm	None Allowed	Allowed with a minimum separation of 12"	Allowed with a minimum separation of 24"
(≥.02" - <.032")			
(≥1/50" - <1/32")			
≥ .80mm - <1.20mm	None Allowed	Allowed with a minimum separation of 60"	Allowed with a minimum separation of 48"
(≥.032" - <.047")			
(≥1/32" - <3/64")			
≥ 1.20mm - <1.50mm	None Allowed	None Allowed	Allowed with a minimum separation of 60"
(≥.047" - <.059")			
(≥3/64" - <1/16")			
≥ 1.50mm	None Allowed	None Allowed	None Allowed
(≥.059")			
(≥1/16")			

- Inspect for point blemishes at **36"** per viewing conditions in FIG. 1, **±10 degrees**. All point blemishes not readily apparent at this distance are allowed.
- Point blemish size = (width + length) / 2
- Point blemish size for this inspection includes any associated distortion

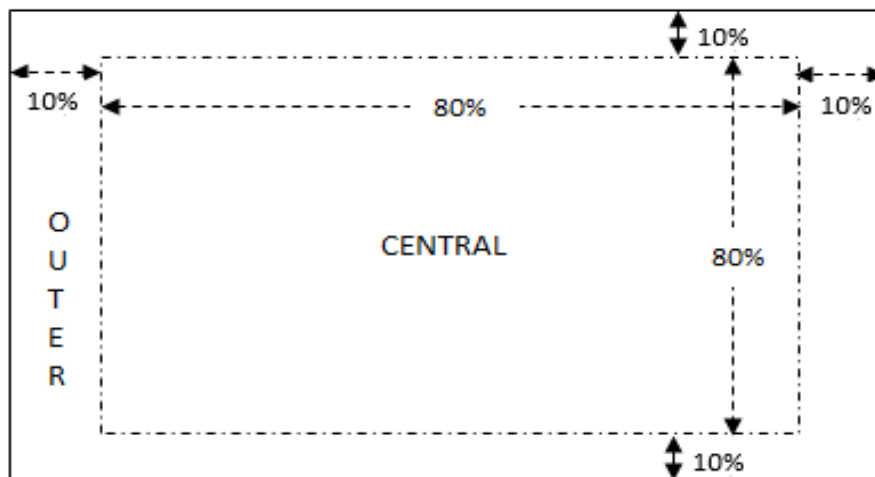

Chip Tolerance <i>(on clean cut or seamed edges) (see p. 21 for chip visual aids)</i>			
GLASS THICKNESS	CHIP DEPTH max (25% of mirror thickness)	CHIP WIDTH max	CHIP LENGTH max
3/32"	3/128"	1/16"	1/8"
1/8"	1/32"		
5/32"	5/128"		
3/16"	3/64"		
1/4"	1/16"		
Stock Sheet	≤ 50% of mirror thickness	Not Limited	Not Limited

- No V-chips allowed
- Corner chips fall under size tolerance allowances

Dimensional Size Tolerance		
MIRROR THICKNESS	WIDTH and LENGTH	
	CLEAN CUT or SEAMED EDGE	STOCK SHEET
3/32" - 1/4"	1/16"	1/4"

Squareness Tolerance		
MIRROR THICKNESS	<i>(measured diagonally corner to corner)</i>	
	CLEAN CUT or SEAMED EDGE	STOCK SHEET
3/32" - 1/4"	5/64"	N/A

Quality Specifications for: **TEMPERED GLASS**

This section covers the criteria and tolerances that are specific to fully tempered glass of all types. These specifications meet or exceed ASTM C1048 Standard Specification for Heat-Treated Flat Glass.

BOW and WARP Tolerance:

Bow and warp in tempered glass is the curvature across the entire specified dimension of the lite of glass. The processes used in manufacturing tempered glass cause it to be not as flat as annealed glass. The deviation from flatness depends on thickness, width, length, and other factors. In general, greater thickness yields flatter glass.

To determine if glass is within allowable limits for bow and warp, use the following test method.

Test Method:

1. Place glass in a freestanding vertical position, resting on blocks at the quarter points.
2. Place a straight edge across the concave side, parallel to and within 1" of the glass edge. If a straight edge is impractical, a string may be stretched around the glass within 1" of the glass edge.
3. Measure the widest gap with a feeler gauge or other measuring device.
4. Refer to Bow and Warp Maximum Limits table.

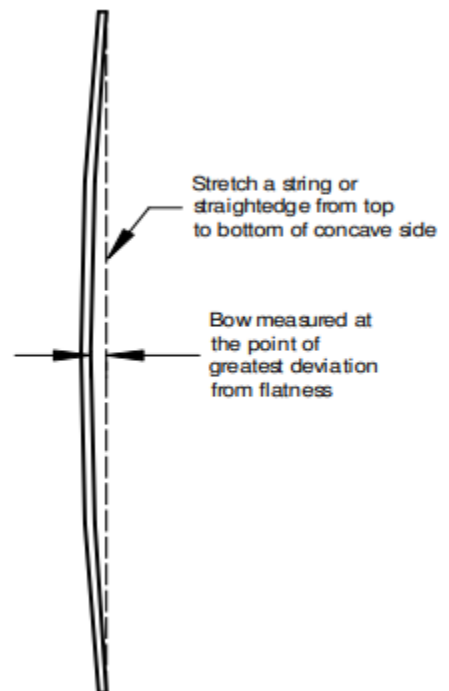

HG - Bow & Warp Maximum Limits										
	EDGE DIMENSIONS IN INCHES (WIDTH/LENGTH OF GLASS)									
	<u>0-24</u>	<u>24-36</u>	<u>36-48</u>	<u>48-60</u>	<u>60-72</u>	<u>72-84</u>	<u>84-96</u>	<u>96-108</u>	<u>108-120</u>	<u>120-132</u>
GLASS THICKNESS										
<u>1/8"</u>	1/8"	1/8"	3/16"	1/4"	5/16"	3/8"	-	-	-	-
<u>5/32"</u>	1/8"	1/8"	3/16"	1/4"	5/16"	3/8"	7/16"	-	-	-
<u>3/16"</u>	1/8"	1/8"	3/16"	1/4"	9/32"	11/32"	7/16"	9/16"	11/16"	-
<u>1/4"</u>	1/16"	3/32"	1/8"	5/32"	3/16"	7/32"	11/32"	7/16"	9/16"	11/16"
<u>3/8"</u>	1/16"	1/16"	1/16"	3/32"	1/8"	5/32"	3/16"	1/4"	13/32"	15/32"
<u>1/2" & UP</u>	1/32"	1/16"	1/16"	1/16"	3/32"	1/8"	5/32"	7/32"	11/32"	13/32"

Localized Bow and Warp

Localized bow and warp for rectangular glass should not exceed 1/16" over any 12" span.

Distortion

Tempered glass is made by heating glass in a furnace, followed by a rapid cooling with air. The original flatness of the glass is modified by the heat treatment, which can cause reflected images to appear distorted. This is a normal part of the heat-treating process, and is not considered a defect. Regardless of glass flatness, the degree of distortion perceived is largely due to the characteristics or symmetry of the object(s) being reflected.

Any requirements for distortion, roller wave, consistent furnace orientation, or distortion measurement must be disclosed at quotation and order.

Size Recommendations for Tempered Glass

INSULATED GLASS-

TABLE 1: Recommended maximum length for TEMPERED insulated glass. Limitations are based on manufacturing and safe handling limits. IGUs that exceed these recommendations are not covered by warranty for bow and warp.

Table 1- INSULATED GLASS (TEMPERED)	
GLASS THICKNESS	MAXIMUM LENGTH
1/8"	80"
5/32"	90"
3/16"	100"
1/4"	128"

FIXED INTERIOR MONOLITHIC GLASS-

The fixed panels of interior glass partitions mounted or restrained on only two sides (top and bottom) require special design considerations. These recommendations address an issue of concern in these applications that has frequently occurred. Glass held on only two sides is much more flexible than glass supported on all four sides. Some installations have been under-designed and installed with inadequate glass thickness. This can result in excessive glass deflection under indoor loads caused by stack action, HVAC changes, doors to the outdoors opening and closing, and people pushing or leaning on the glass.

Glass that is too thin can tremble, shimmer or deflect excessively, even though the tempered glass meets design probability of breakage requirements. As the unsupported span or height of the glass panels increases, the glass thickness must also increase to maintain a reasonable stiffness.

TABLE 2: Recommended MINIMUM thickness for tempered glass used in butt-glazed (vertical edges unsupported) fixed interior glass panels mounted or restrained at top and bottom only.

Table 2 – FIXED INTERIOR GLASS PANELS (TEMPERED)	
Unsupported span from top to bottom of glass	Recommended minimum thickness of TEMPERED glass
Up to 5'	1/4"
5' – 8'	3/8"
8' – 10'	1/2"
10' – 14'	3/4"
Over 14'	Contact Sales

CAUTIONS:

Structural joints or permanently clipping adjacent panels do not add to the structural strength or rigidity of the assembly, and do not permit reduction of the recommended thicknesses shown in TABLE 2.

Open narrow joints between butt-glazed glass panels may catch or pinch fingers. The best preventative is to avoid open joints by filling them with silicone. An alternative is to install permanent clamps approximately every four feet to couple the adjoining panels together. This helps prevent relative movement between panels. The gap between panels with unfilled joints should be such that fingers cannot be inserted and trapped.

FIXED EXTERIOR MONOLITHIC GLASS-

For outdoor applications of butt-joint glazing, with higher design wind loads than indoor applications, similar under-designed use of glass have also occurred. To address such applications, use ASTM E1300 "Standard Practice for Determining the Minimum Thickness of Annealed Glass Required to Resist a Specified Load".

INTERIOR and EXTERIOR MONOLITHIC SWINGING DOORS-

Door sizes need to be limited due to glass flexibility and hardware limitations. Closers and pivots have weight limitations. Doors that are too wide are difficult to control in windy conditions and may exceed hardware limits. Full rails top and bottom are recommended for larger door sizes.

Table 3 recommends the maximum interior and exterior swing door sizes using various glass and hardware options. These maximum sizes consider both the hardware manufacturer's design limitations and glass deflection considerations.

Table 3							
Recommended Maximum Interior or Exterior Swinging Door Sizes							
Fully Tempered Glass							
		Full Rails			Patch Fittings		
Glass Thickness		10mm (3/8")	12mm (1/2")	19mm (3/4")	10mm (3/8")	12mm (1/2")	19mm (3/4")
Glass Weight		[5 lbs/sf]	[6.5 lbs/sf]	[10 lbs/sf]	[5 lbs/sf]	[6.5 lbs/sf]	[10 lbs/sf]
Concealed	Width	914mm (36 in.)	1065mm (42 in.)	914mm (36 in.)	914mm (36 in.)	1065mm (42 in.)	914mm (36 in.)
	Height	2130mm (84 in.)	2740mm (108 in.)	2130mm (84 in.)	2130mm (84 in.)	2590mm (102 in.)	2130mm (84 in.)
Overhead	Glass Weight	(105 lbs.)	(205 lbs.)	(210 lbs.)	(105 lbs.)	(194 lbs.)	(210 lbs.)
Floor	Width	914mm (36 in.)	1220mm (48 in.)	1220mm (48 in.)	914mm (36 in.)	1065mm (42 in.)	914mm (36 in.)
	Height	2130mm (84 in.)	2740mm (108 in.)	3048mm (120 in.)	2130mm (84 in.)	2590mm (102 in.)	2440mm (96 in.)
Closer	Glass Weight	(105 lbs.)	(234 lbs.)	(400 lbs.)	(105 lbs.)	(194 lbs.)	(240 lbs.)

SLIDING DOORS-

Tempered sliding glass doors can be utilized in slider door systems using either floor mounted or top mounted rollers. The weight of the sliding doors can be supported by rollers on a floor track or suspended from rollers in an overhead track.

The size and weight limitations for sliding doors are largely dependent on the type of hardware used. Your sales representative can assist you with choosing the correct hardware and other design considerations for your sliding glass door application.

Fixed Monolithic Glass and Swinging Door information and recommendations reprinted from GANA (Glass Association of North America) Tempered Heavy Glass Door and Entrance Systems Design Guide, 1999 edition.

Quality Specifications for: **LAMINATED GLASS**

This section covers the criteria and tolerances for the laminated interlayer and blemishes associated with laminating, cutting and fabricating laminated glass. For inspection of the individual glass lites, refer to the appropriate section for the individual lite of glass (FLAT GLASS, MIRROR, etc). These specifications are based on ASTM C1172 Standard Specification for Laminated Flat Glass.

1. Inspect laminated glass at **36"** per conditions in FIG 1. Blemishes not readily apparent at this distance are allowed without restriction. Otherwise, proceed to step 2.
2. Determine glass surface area (ft²).
3. Determine defect location - CENTRAL or OUTER viewing area.
4. Evaluate blemish according to the following table:

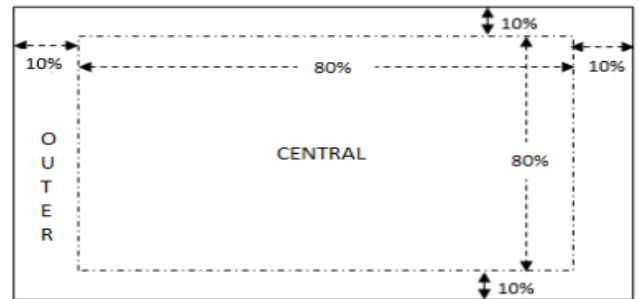

BLEMISH <i>maximum allowable</i>	Up to 25 ft ²		25ft ² +		Stock Sheet	
	Central	Outer	Central	Outer	Central	Outer
Chip , Short Interlayer or Unlaminated Area	-	1/4"	-	1/4"	-	1/4"
Inside dirt (dirt spot)	1/16"	3/32"	3/32"	5/32"	1/8"	3/16"
Discoloration or Delamination	none	none	none	none	none	none
Boil	1/16"	3/32"	1/8"	3/16"	1/4"	1/4"
Blow-in or Edge Boil	-	1/4"	-	1/4"	-	5/16"
Fuse	1/32"	1/16"	1/16"	3/32"	3/32"	5/32"
Hair or Lint	light intensity	medium intensity	light intensity	medium intensity	medium intensity	medium intensity
Scuff or Streak	light intensity	medium intensity	medium intensity	medium intensity	medium intensity	medium intensity
ALL BLEMISHES NOTED MUST BE SEPERATED BY A MINIMUM OF 12"						

- *Light intensity*: barely noticeable at 36"
- *Medium intensity*: noticeable at 36" but not at 120" (10 ft)
- Missing corner chips allowed on 1 lite of laminate only. 2nd lite must meet appropriate width and length tolerances.
- Laminates with more than 2 lites of glass may contain proportionally more blemishes.

Size Tolerance <i>(including mismatch)</i>			
TOTAL LAMINATE THICKNESS	Up to 25 ft ²	Over 25 ft ²	STOCK SHEET
	CLEAN CUT or SEAMED EDGE	CLEAN CUT or SEAMED EDGE	
≤ 1/4"	± 1/16"	+ 3/32" , - 1/16"	± 1/2"
> 1/4" - 1/2"	+ 1/8" , - 1/16"	+ 5/32" , - 1/16"	± 1/2"
> 1/2"	± 1/8"	+ 5/32" , - 1/8"	± 1/2"
SQUARENESS TOLERANCE <i>(measured diagonally)</i>	± 3/16"	± 3/8"	N/A

Thickness Tolerance (all sizes) = ± 1/32"

Quality Specifications for: **INSULATED GLASS**

This section defines the quality standards, size tolerances and appearance criteria that apply to dual sealed Insulated Glass Units (IGUs). These specifications are based on IGCC (Insulating Glass Certification Council) and IGMA (Insulating Glass Manufacturers Alliance) quality assurance procedures, guidelines and specifications, as well as ASTM C1036 Standard Specification for Flat Glass, Quality 3 (Q3) or better.

Primary Seal (*butyl, PIB or polyisobutylene*) -

PLACEMENT:

Primary seal should not be exposed at any point along the outer edge of the IGU. Primary seal is allowed to enter the air space of the IGU, as long as it does not exceed overall sightline specification.

SEAL WIDTH:

A minimum primary seal width of $1/16$ " is allowed for a maximum total length of 8" for the entire IGU. The minimum primary seal width for the rest of the IGU is $1/8$ ".

GAPS:

No gaps or skips are allowed in the primary seal.

DEBRIS:

Minor debris is permitted in the primary seal, but seal width and gap requirements must be met.

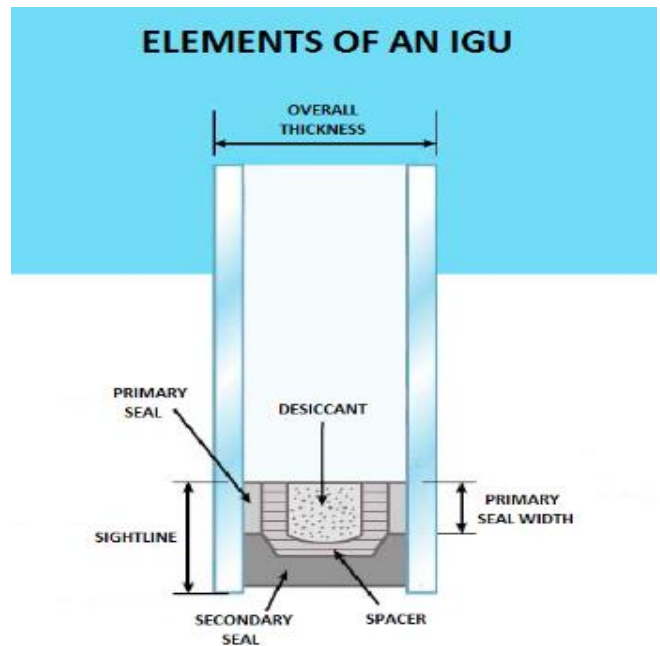

Secondary Seal (*silicone or polyurethane*) -

COVERAGE:

Secondary seal must cover the entire outer surface of the spacer. The outer surface of the spacer should not be exposed or visible at any point.

SEAL THICKNESS:

The minimum fill thickness of the secondary seal is $1/16$ ", as measured from the outer surface of the spacer to the thinnest point of the secondary seal.

SEAL OVERFILL:

Up to $3/32$ " of overfill is allowed from the glass edge.

VOIDS:

Voids or separations between primary and secondary seal are permitted to a maximum width of 1/16" by a maximum length of 6" with gaps separated by at least 16".

CORNER VOIDS:

Up to 3/32" from the primary seal edge to the continuation of the secondary seal.

DEBRIS:

Minor debris is permitted in secondary seal, but seal thickness, coverage, and void requirements must be met.

Sight Line -**DEFINITION:**

The sight line is defined as the perimeter area of the IGU that contains the primary seal, secondary seal and spacer. The sight line is measured from the outside edge of the glass (largest lite) to the inside edge of the sight line (spacer or primary seal).

STANDARD SIGHT LINE TOLERANCES:

- Mill spacer: 7/16", ± 1/8"
- Super Spacer: 7/16", ± 1/16"

EDGE DELETE for SOFT COAT LOW-E (272):

- 7/16", ± 1/16"

Glass Surface Cleanliness -**WITHIN SIGHT LINE:**

Up to 1/64" of excess sealant on the outer surface of each pane of glass within the sight line of the IGU is allowed.

DAYLIGHT OPENING:

The daylight opening is defined as the central glass area between the sight lines of the IGU that is looked through unobstructed.

Minor glass surface obstructions in the daylight opening (fingerprints, smudges, etc) that are easily removed with common glass cleaning methods (glass cleaner, isopropyl alcohol, etc) are allowed.

Size Tolerances –**OVERALL (OA) THICKNESS TOLERANCE:**

(multiple configurations default to larger tolerance)

Standard: + 1/32" / -1/16"

IGUs with 1/4" glass: + 1/32" / -3/32"

IGUs with patterned, laminated, or wire glass: ± 1/16"

IGUs with 3/16" mill spacer using 3/32" glass: ± 1/16"

IGUs with 3/16" mill spacer using 1/8" or thicker glass: + 3/32" / -1/16"

Triple pane IGUs: ± 1/16"

Triple pane IGUs using 3/16" mill spacer: + 1/8" / -1/16"

WIDTH AND HEIGHT TOLERANCE:

IGUs with:

Both Width and Height Dimension < 80": ± 1/16"

1 or more Width or Height Dimension ≥ 80": + 1/8" / - 1/16"

Laminated or Wire glass: + 1/8" / - 1/16"

Custom shape 99 glass (customer provided pattern): ± 1/8"

Edgework on 1 or more lites: ± 1/8"

SQUARENESS TOLERANCE:

± 1/4"

GRID PLACEMENT and SQUARENESS TOLERANCE:

± 1/16"

Blemish Tolerances –

Linear Blemish (<i>scratch, rub, dig or similar imperfections – see p. 21 for examples</i>)		
BLEMISH INTENSITY	DETECTION DISTANCE	LINEAR BLEMISH TOLERANCE
Heavy	Over 11'	None allowed
Medium	11' to 36"	None allowed
Light	36" to 8"	Allowed
Faint	Under 8"	Allowed

- To determine blemish intensity, stand at approximately **12'** under viewing conditions in FIG. 1. Move closer until blemish becomes readily apparent. This is the detection distance.

Point Blemish (<i>seed, dirt or similar imperfections – see p. 21 for examples</i>)	
POINT BLEMISH SIZE	POINT BLEMISH TOLERANCE
< 1/32"	Allowed
1/32" – 1/16"	Allowed with a minimum separation of 24"
>1/16"	None allowed

- Inspect for point blemishes at **36"** per viewing conditions in FIG. 1. All point blemishes not readily apparent at this distance are allowed.
- Point blemish size = (width + length) / 2
- Point blemish size for this inspection does not include any associated distortion.

Chips (<i>see p. 21 for chip visual aids</i>)			
GLASS THICKNESS	CHIP DEPTH max (up to 50% of glass thickness)	CHIP WIDTH max	CHIP LENGTH max
3/32"	3/64"	1/8"	1/4"
1/8"	1/16"	1/8"	1/4"
5/32"	5/64"	5/32"	1/2"
3/16"	3/32"	3/16"	
1/4"	1/8"	1/4"	

- No V-chips are allowed
- Corner chips fall under size tolerance allowances

INTERNAL BLEMISH:

Any perceived blemish that is on or in the internal surfaces of glass or spacer of the IGU that is not readily apparent from **36"** under the viewing conditions shown in FIG. 1 is allowed.

NON-STANDARD LITES:

For any perceived blemish on a lite that is not covered in this document (laminated glass, glass with edgework, etc.), refer to the appropriate section for the individual lite of glass.

BOW and WARP:

Refer to Tempered Glass section for tempered glass bow and warp tolerances.

Quality Specifications for:

METAL FABRICATION

This section covers the criteria and tolerances specific to metal shop fabrication at HG.

Fabrication Guidelines:

- Metal will be built to Tubelite specifications
- Framing with screw spline joints will be assembled
- Framing with shear blocks will be fabricated and shipped KD
 - Exception: Door jambs with shear blocks will be assembled

Dimensional Size Tolerance:

- Frame dimension size:
 - up to 120": $\pm 1/16$ "
 - 120"-200": $\pm 1/8$ "
 - Add $\pm 1/16$ " each additional 100"

Joints:

- Joints should be visibly flush
- Joints should be tight. No daylight visible
- No excess silicone should be present



Joints (continued):

- Cut ends should be filed/deburred

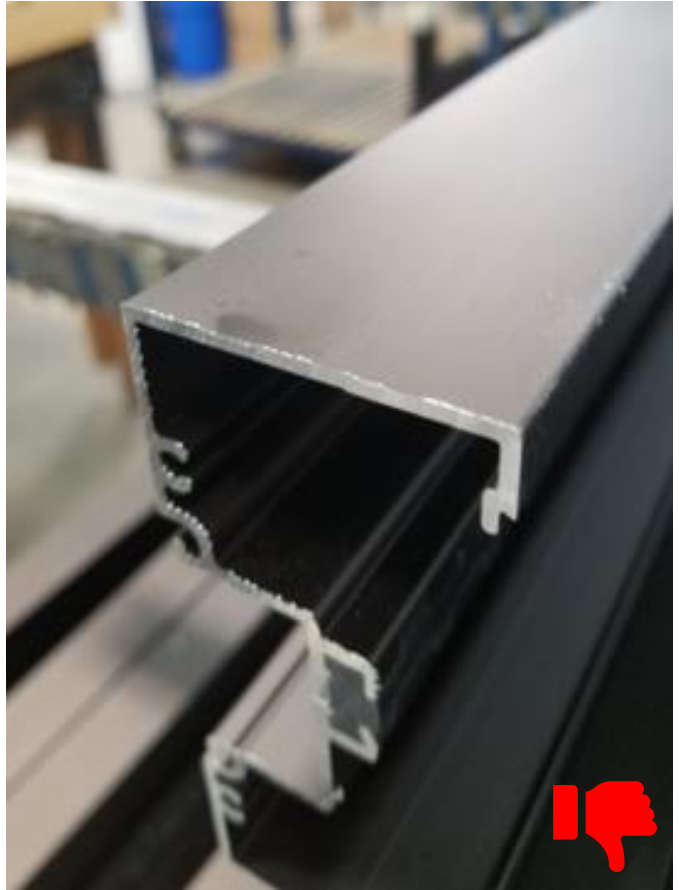

- Joint placement tolerance: $\pm 1/32$ "
- Joint squareness tolerance: $1/32$ " max

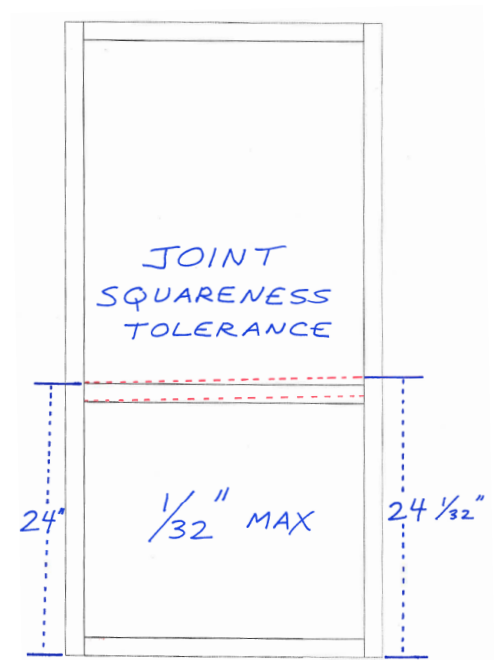
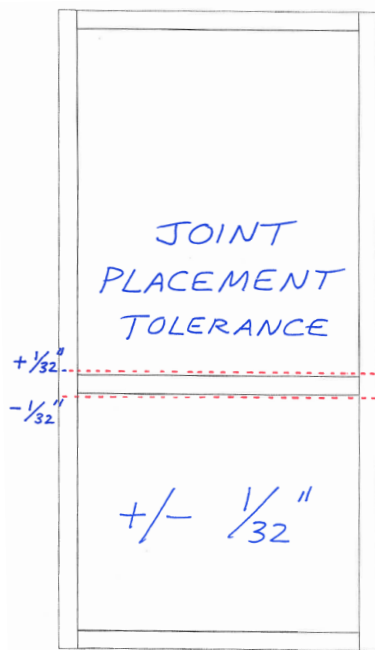

Hardware:

- Installed hardware should be tight to metal surface
- Hinges, mortise locks, etc. should be visibly flush
- Hardware placement tolerance: $\pm 1/16"$
- Handles, panics, etc. should be straight
 - Tolerance: $1/16"$ out of square max



Screws:

- Frame screws should be tight to metal surface
- Hardware screws should be tight and flush or slightly countersunk to metal surface



Terminology:

associated distortion—alteration of viewed images caused by variations in glass flatness or inhomogeneous portions within the glass

bevel—angled surface at the edge of a lite of glass

blemish—imperfection in the body or on the surface of the glass

blow-in—a separation of glass and interlayer at or close to the laminate edge

boil—a bubble or gas pocket in the interlayer material or between the glass and interlayer

bow—a condition in which a lite of flat glass departs from a true plane

chip depth—measured distance of a chip from the face of the glass into the thickness

chip length—maximum distance parallel to the edge of the glass from one edge of a chip to the other

chip width—maximum perpendicular distance from the edge of the glass to the inner edge of the chip

clam— see shell chip

clear glass—glass formulated to have transmittance in the visible spectrum greater than 82 % at a standard thickness of 6 mm (1/4 in.) with lack of color as compared to tinted glass of the same thickness

cluster—a group of not less than 3 point blemishes separated by not more than 50 mm (2 in.)

crush—pitted condition with a dull appearance

cut size—glass ordered cut to its final intended size

delamination—a condition in which one or two of the lites of glass loses the bond between the glass lite and the interlayer

dig—a deep scratch in the glass surface

direct lighting—lighting in which the greater part of the light goes directly from the source to the area lit

dirt—small particle of foreign matter embedded in the surface of the glass

edge boil—See boil

flare—protrusion on the glass edge or corner of an otherwise rectangular surface

fuse—a glass particle or crystalline material that is permanently bonded to a surface of a lite

hair—a slender, pigmented filament from human or animal epidermis or other thread-like filament

inside dirt—foreign material trapped inside the laminate

interlayer—a layer or multiple layers of material acting as an adhesive between lites of glass which adds additional performance to the finished product

KD— (knock down) product supplied unassembled, with all components needed for assembly

laminated glass—an assembly consisting of two or more lites of glass that are bonded together by interlayer material.

linear blemish—scratch, rub, dig and other similar imperfections, which may be straight or curved in nature. If curved, the length of such a blemish is to be measured from end to end along the curve

lint—short fibers of yarn or fabric trapped within the laminate.

lite or light—a panel or sheet of glass

low iron glass—glass formulated to have transmittance in the visible spectrum higher than that of clear glass of the same thickness

mismatch— misalignment of the edges of two lites of glass when laminated

oyster— see shell chip

point blemish—seed, dirt, crush, stone and other similar imperfections

rub—abrasion of a glass surface producing a frosted appearance

scratch—an abrasion of a glass surface in the form of a curved line, a straight line or both

scuff—See streak

seed— round or elongated bubble in the glass

shell chip—circular indentation in the glass edge as a result of breakage of a small fragment
shiner—an area on a glass edge that has not been ground or polished
short interlayer—a condition of the laminate in which the interlayer does not extend to the edge
silver film blemish—visible clouding, spot silver faults and other similar imperfections of the silver coating
skip— see shiner
spot silver fault—a small area at which the silver coating is partially or entirely absent
stock sheet—glass ordered in sizes intended to be cut to create final or cut size
stone—crystalline inclusion in glass
streak—a noticeably visible deviation on or in the laminating unit
tinted glass—glass formulated to have a uniform color throughout the glass, with the purpose of reducing glare
(visible transmittance), solar heat gain or visible/ultraviolet (UV) transmittance
unlaminated area—an area of the laminate that failed to laminate during the lamination process. This blemish may be discernable due to the textured appearance of the interlayer material
v-chip—a v-shaped imperfection in the edge of the glass lite
visible clouding—a frosted appearance in the reflected image from a silvered mirror

Visual Aids:

LINEAR BLEMISHES-

scratch

rub

dig



POINT BLEMISHES-

seed

dirt



CHIPS-

shell chip

v-chip

chip dimensions



EDGE DEFECTS-

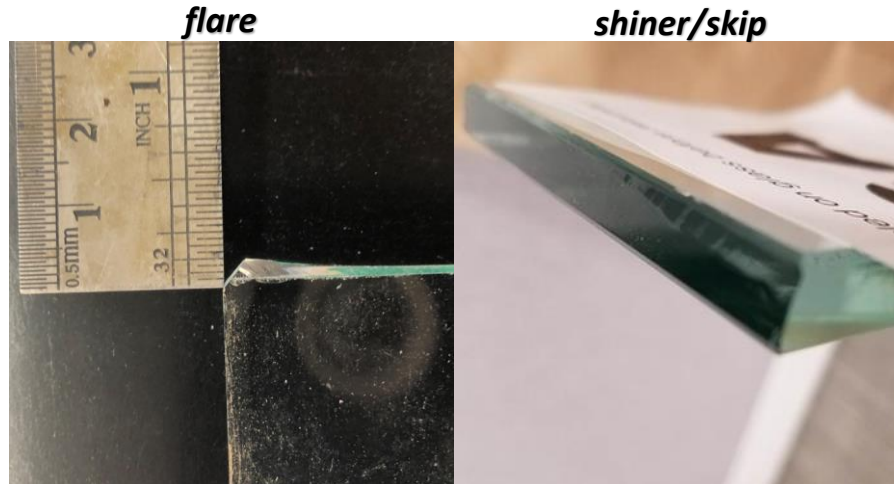

REVISION TABLE			
<i>Revision</i>	<i>Description</i>	<i>Date</i>	<i>Initials</i>
1.0	Production release - "HG Quality Specifications"	3/25/19	EM
1.1	First revision - General release	5/22/19	EM
1.11	Added Table of Contents	5/30/19	EM
1.12	Revised IG OA tolerances	6/5/19	EM
1.13	Added Super Spacer standard sightline, Wire glass in IG OA	10/16/19	EM
1.2	Added Section "Metal Fabrication"	10/9/20	EM
1.21	Added IG low-e (272) edge delete tolerance	10/16/20	EM
1.22	Updated page references, add edge defect visual aids	12/1/20	EM

This document is intended to inform and assist the reader in the application, use, and maintenance of Heartland Glass products. Actual performance and results can vary depending on the circumstances. Heartland Glass makes no warranty or guarantee as to the results to be obtained from the use of all or any portion of the information provided herein, and hereby disclaims any liability for personal injury, property damage, product insufficiency, or any other damages of any kind or nature arising from the reader's use of the information contained herein.